

SPACE UNSCRAMBLE THE WORDS

Unscramble the space vocabulary and number the pictures

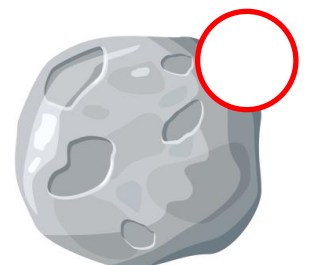
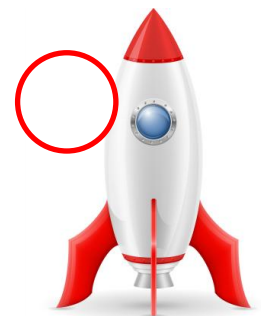
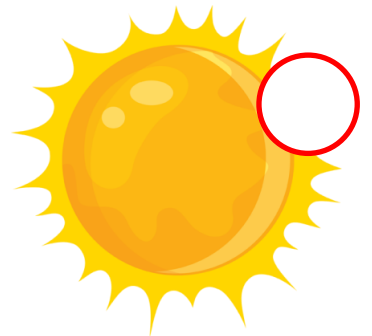
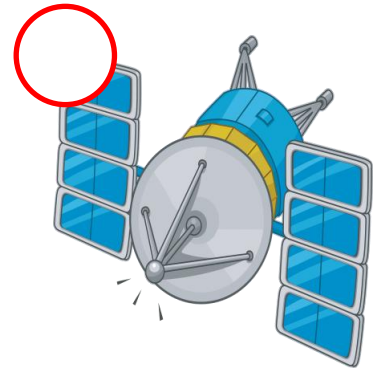
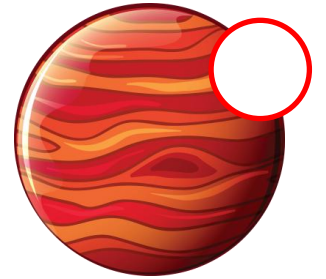
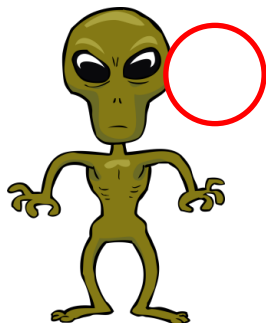
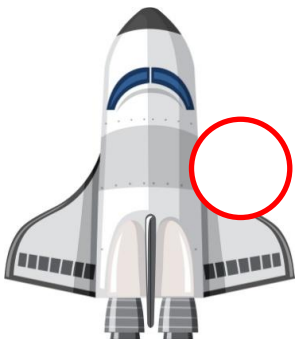
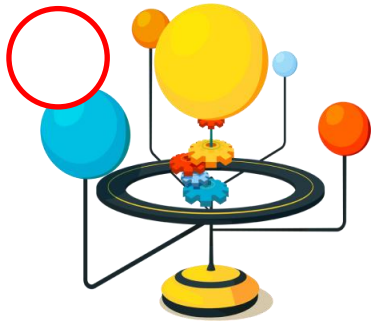
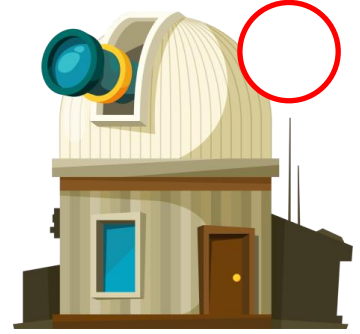
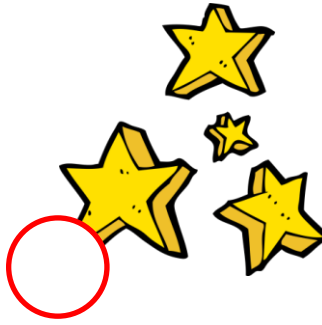
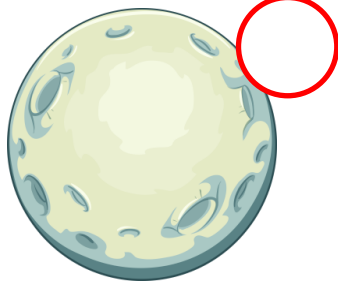
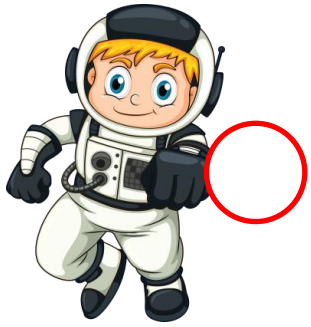

1. tteluhs _____
2. toeleescp _____
3. naetpl _____
4. iemrtteo _____
5. nsu _____
6. anrstoua _____
7. rosaited _____
8. uof _____
9. heart _____
10. aosrl myesst _____
11. btroavesory _____
12. srsta _____
13. ecrtok _____
14. ilean _____
15. Itaseitle _____
16. nomo _____

SPACE UNSCRAMBLE THE WORDS ANSWER KEY

Unscramble the space vocabulary and number the pictures

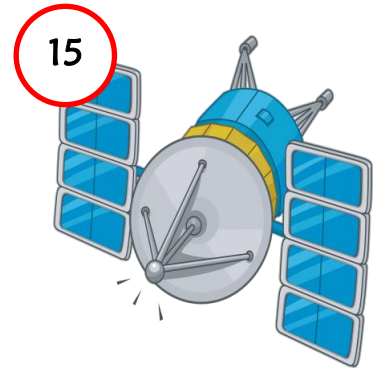
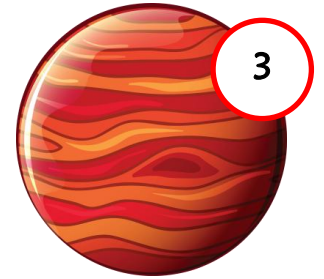
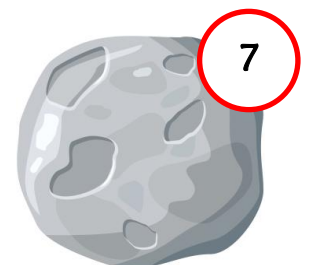
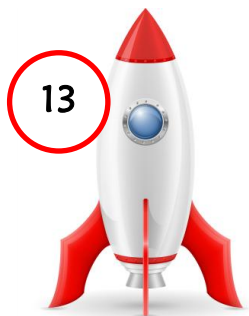
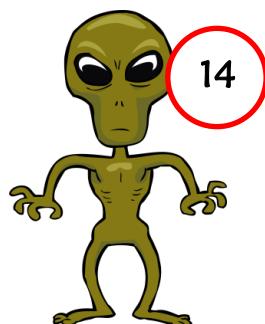
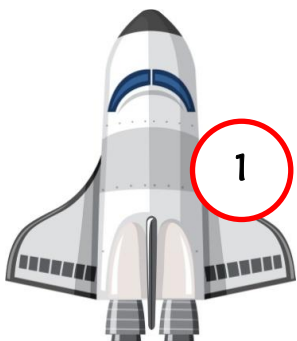
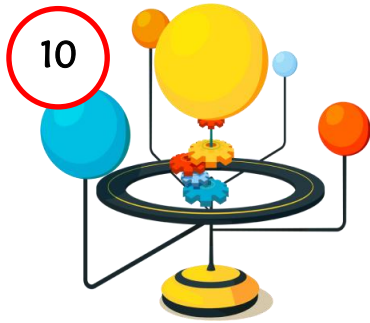
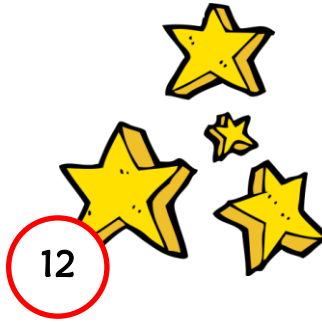

- | | |
|------------------|--------------|
| 1. tteluhs | shuttle |
| 2. toeleescp | telescope |
| 3. naetpl | planet |
| 4. ieemrtteo | meteorite |
| 5. nsu | Sun |
| 6. anrsttoa | astronaut |
| 7. rosaited | asteroid |
| 8. uof | ufo |
| 9. heart | Earth |
| 10. aosrl myesst | solar system |
| 11. btroavesory | observatory |
| 12. srsta | stars |
| 13. ecrtok | rocket |
| 14. ilean | alien |
| 15. ltaseitle | satellite |
| 16. nomo | Moon |